

500mA Low Dropout Voltage Regulator

■ GENERAL DESCRIPTION

The NJU7223 series is a high precision output voltage, low drop output, low current consumption and high output current 3-terminal positive voltage regulator with a over current protection and a thermal shutdown.

Low dropout voltage is realized at high current output.

■ FEATURES

- High Precision Output $\pm 2.0\%$
- Output Current $I_o(\text{max.})=500\text{mA}$
- Low Current Consumption $I_q=30\mu\text{A}$
- Low Dropout Voltage $0.4\text{V typ. } (I_o=500\text{mA}, V_o=5.0\text{V})$
- Internal Over Current Protection
- Internal Thermal Shutdown Protection
- CMOS Technology
- Package Outline TO-220F, TO-252

■ PACKAGE OUTLINE

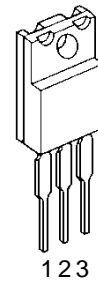

1 2 3

NJU7223F

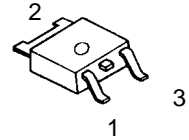

2 1 3

NJU7223DL1

■ PIN CONFIGURATION

1. V_{OUT}
2. V_{IN}
3. GND

■ EQUIVALENT CIRCUIT

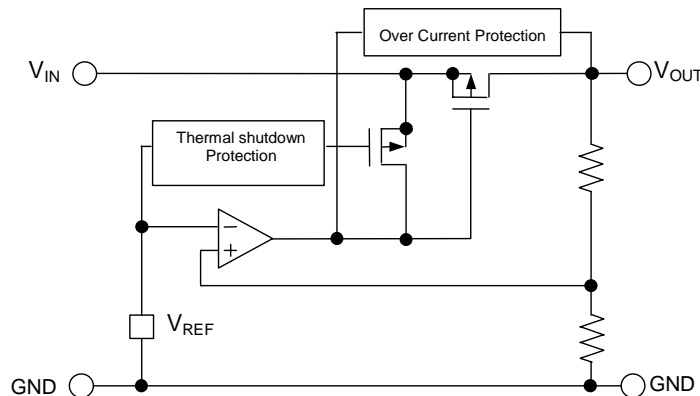

■ OUTPUT VOLTAGE RANK LIST

| V_{OUT} | TO-220F | TO-252 |
|-----------|------------|---------------|
| +1.8V | NJU7223F18 | NJU7223DL1-18 |
| +2.5V | NJU7223F25 | NJU7223DL1-25 |
| +3.0V | NJU7223F30 | NJU7223DL1-30 |
| +3.3V | NJU7223F33 | NJU7223DL1-33 |
| +5.0V | NJU7223F50 | NJU7223DL1-50 |

NJU7223

■ ABSOLUTE MAXIMUM RATINGS (Ta=25°C)

| PARAMETER | SYMBOL | RATINGS | UNIT |
|-----------------------------|-----------|---|------|
| Input Voltage | V_{IN} | +18 | V |
| Output Voltage | V_{OUT} | GND-0.3 ~ $V_{IN} + 0.3$ | V |
| Output Current | I_{OUT} | 700 | mA |
| Power Dissipation | P_D | TO-220F 7.5(Tc≤85°C) TO-252 7.5(Tc≤56°C) 1.0(Ta=25°C) | W |
| Operating Temperature Range | Topr | -40 ~ 85 | °C |
| Storage Temperature Range | Tstg | -55 ~ 150 | °C |

■ TEST CIRCUIT

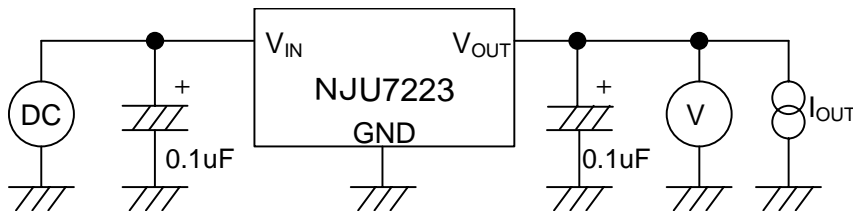

■ ELECTRICAL CHARACTERISTICS ($C_{IN}=C_O=0.1\mu F$, $T_j=25^\circ C$)

Measurement is to be conducted in pulse testing.

| PARAMETER | SYMBOL | TEST CONDITION | MIN. | TYP. | MAX. | UNIT |
|------------------------|-------------------------------------|--|-------|------|-------|---------|
| Vo=1.8V Version | | | | | | |
| Output Voltage | V_O | $V_{IN}=3.8V$, $I_o=300mA$ | 1.764 | 1.80 | 1.836 | V |
| Input Voltage | V_{IN} | | - | - | 14 | V |
| Dropout Voltage | ΔV_{IO} | $I_o=150mA$ | - | 0.4 | 0.6 | V |
| Line Regulation | $\Delta V_o/\Delta V_{IN}\cdot V_o$ | $V_{IN}=2.8V \sim 12.0V$ | - | 0.10 | - | %/V |
| Load Regulation | $\Delta V_o/\Delta I_o$ | $V_{IN}=3.8V$, $I_o=1 \sim 500mA$ | - | 120 | 160 | mV |
| Quiescent Current | I_{DD} | $V_{IN}=3.8V$ | - | 30 | 60 | μA |
| Ripple Rejection | RR | $V_{IN}=3.8V$, $e_{in}=1V_{P-P}$ $f=120Hz$, $I_o=300mA$ | - | 57 | - | dB |
| Output Noise Voltage | V_{NO} | $V_{IN}=3.8V$, $I_o=300mA$ $BW=10Hz \sim 100kHz$ | - | 65 | - | μV |
| Vo=2.5V Version | | | | | | |
| Output Voltage | V_O | $V_{IN}=4.5V$, $I_o=300mA$ | 2.45 | 2.50 | 2.55 | V |
| Input Voltage | V_{IN} | | - | - | 14 | V |
| Dropout Voltage | ΔV_{IO} | $I_o=300mA$ | - | 0.4 | 0.6 | V |
| Line Regulation | $\Delta V_o/\Delta V_{IN}\cdot V_o$ | $V_{IN}=3.5V \sim 12.0V$ | - | 0.10 | - | %/V |
| Load Regulation | $\Delta V_o/\Delta I_o$ | $V_{IN}=4.5V$, $I_o=1 \sim 500mA$ | - | 120 | 160 | mV |
| Quiescent Current | I_{DD} | $V_{IN}=4.5V$ | - | 30 | 60 | μA |
| Ripple Rejection | RR | $V_{IN}=4.5V$, $e_{in}=1V_{P-P}$ $f=120Hz$, $I_o=300mA$ | - | 57 | - | dB |
| Output Noise Voltage | V_{NO} | $V_{IN}=4.5V$, $I_o=300mA$ $BW=10Hz \sim 100kHz$ | - | 110 | - | μV |
| Vo=3.0V Version | | | | | | |
| Output Voltage | V_O | $V_{IN}=5.0V$, $I_o=300mA$ | 2.94 | 3.00 | 3.06 | V |
| Input Voltage | V_{IN} | | - | - | 14 | V |
| Dropout Voltage | ΔV_{IO} | $I_o=300mA$ | - | 0.4 | 0.6 | V |
| Line Regulation | $\Delta V_o/\Delta V_{IN}\cdot V_o$ | $V_{IN}=4.0V \sim 12.0V$ | - | 0.10 | - | %/V |
| Load Regulation | $\Delta V_o/\Delta I_o$ | $V_{IN}=5.0V$, $I_o=1 \sim 500mA$ | - | 120 | 160 | mV |
| Quiescent Current | I_{DD} | $V_{IN}=5.0V$ | - | 30 | 60 | μA |
| Ripple Rejection | RR | $V_{IN}=5.0V$, $e_{in}=1V_{P-P}$ $f=120Hz$, $I_o=300mA$ | - | 57 | - | dB |
| Output Noise Voltage | V_{NO} | $V_{IN}=5.0V$, $I_o=300mA$ $BW=10Hz \sim 100kHz$ | - | 115 | - | μV |

■ ELECTRICAL CHARACTERISTICS ($C_{IN}=C_O=0.1\mu F$, $T_j=25^\circ C$)

Measurement is to be conducted in pulse testing.

| PARAMETER | SYMBOL | TEST CONDITION | MIN. | TYP. | MAX. | UNIT |
|-----------------------------------|--------------------------------------|--|-------|------|-------|---------|
| Vo=3.3V Version Output Voltage | V_O | $V_{IN}=5.3V$, $I_o=300mA$ | 3.234 | 3.30 | 3.366 | V |
| Input Voltage | V_{IN} | | - | - | 14 | V |
| Dropout Voltage | ΔV_{IO} | $I_o=300mA$ | - | 0.4 | 0.6 | V |
| Line Regulation | $\Delta V_o/\Delta V_{IN} \cdot V_o$ | $V_{IN}=4.3V \sim 12.0V$ | - | 0.10 | - | %/V |
| Load Regulation | $\Delta V_o/\Delta I_o$ | $V_{IN}=5.3V$, $I_o=1 \sim 500mA$ | - | 120 | 160 | mV |
| Quiescent Current | I_{DD} | $V_{IN}=5.3V$ | - | 30 | 60 | μA |
| Ripple Rejection | RR | $V_{IN}=5.3V$, $e_{in}=1V_{P-P}$ $f=120Hz$, $I_o=300mA$ | - | 56 | - | dB |
| Output Noise Voltage | V_{NO} | $V_{IN}=5.3V$, $I_o=300mA$ $BW=10Hz \sim 100kHz$ | - | 117 | - | μV |
| Vo=5.0V Version Output Voltage | V_O | $V_{IN}=7.0V$, $I_o=500mA$ | 4.90 | 5.00 | 5.10 | V |
| Input Voltage | V_{IN} | | - | - | 14 | V |
| Dropout Voltage | ΔV_{IO} | $I_o=500mA$ | - | 0.4 | 0.6 | V |
| Line Regulation | $\Delta V_o/\Delta V_{IN} \cdot V_o$ | $V_{IN}=6.0V \sim 12.0V$ | - | 0.10 | - | %/V |
| Load Regulation | $\Delta V_o/\Delta I_o$ | $V_{IN}=7.0V$, $I_o=1 \sim 500mA$ | - | 120 | 160 | mV |
| Quiescent Current | I_{DD} | $V_{IN}=7.0V$ | - | 30 | 60 | μA |
| Ripple Rejection | RR | $V_{IN}=7.0V$, $e_{in}=1V_{P-P}$ $f=120Hz$, $I_o=300mA$ | - | 55 | - | dB |
| Output Noise Voltage | V_{NO} | $V_{IN}=7.0V$, $I_o=300mA$ $BW=10Hz \sim 100kHz$ | - | 122 | - | μV |

■ TYPICAL CHARACTERISTICS

Load Transient Response (Vo=3.3V version)

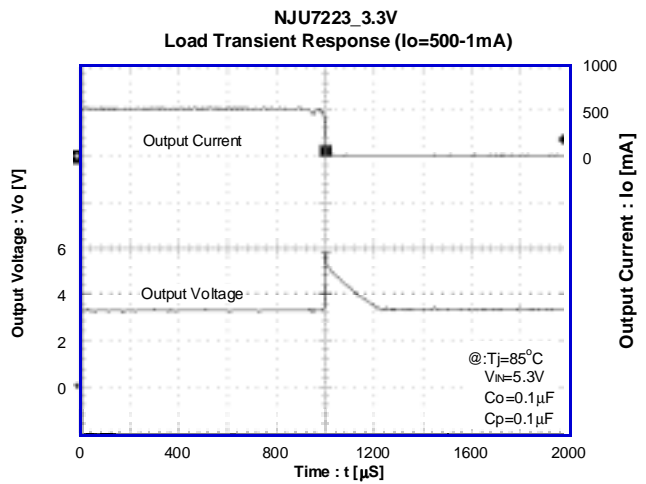
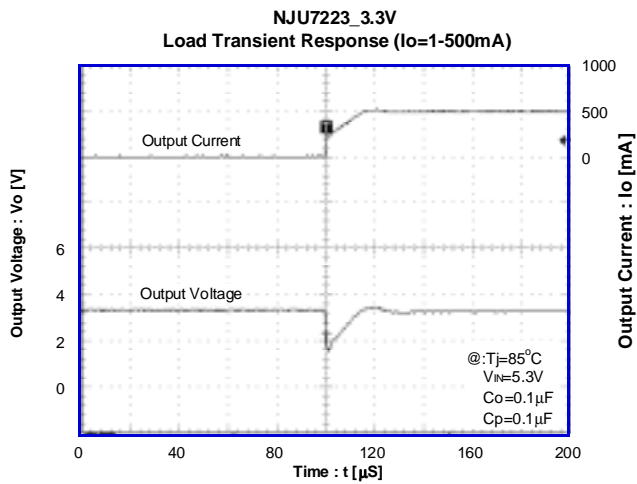
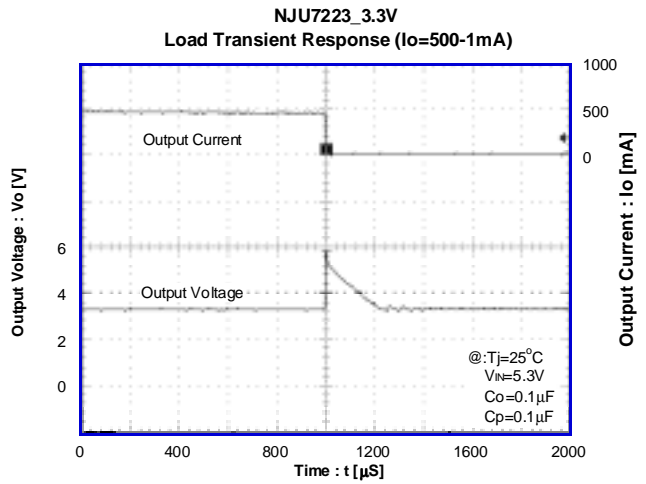
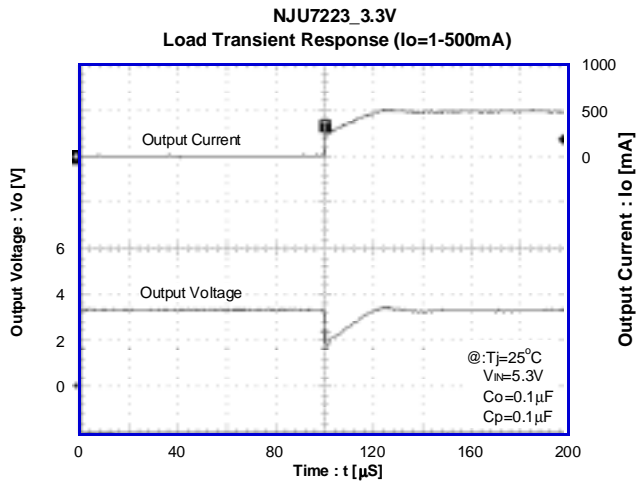
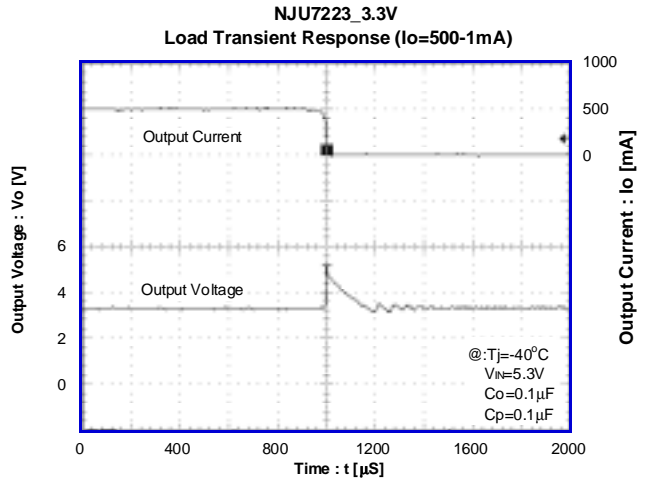
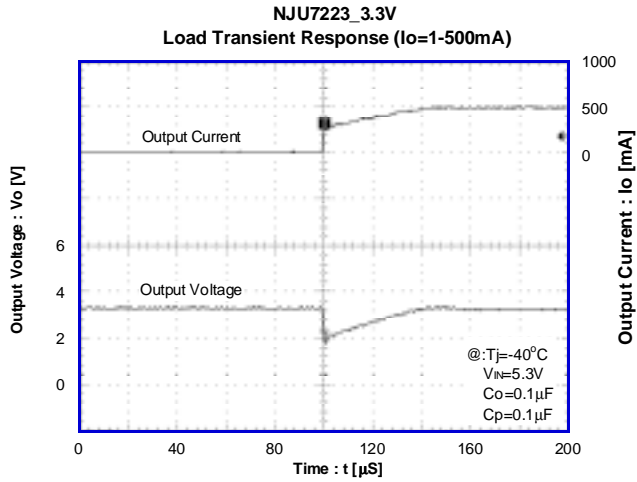

■ TYPICAL CHARACTERISTICS

Load Transient Response (Vo=5.0V version)

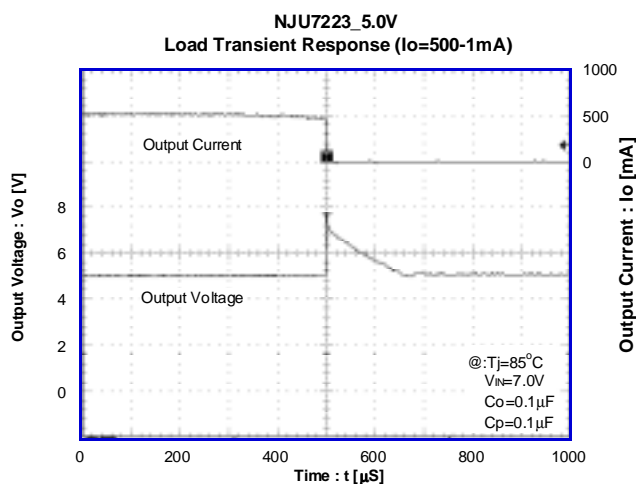
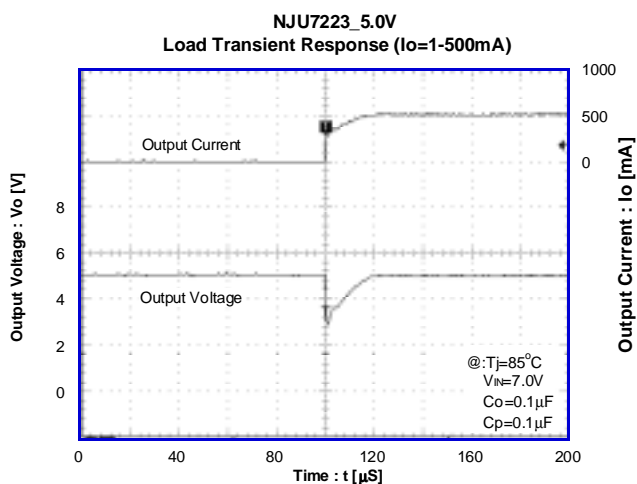
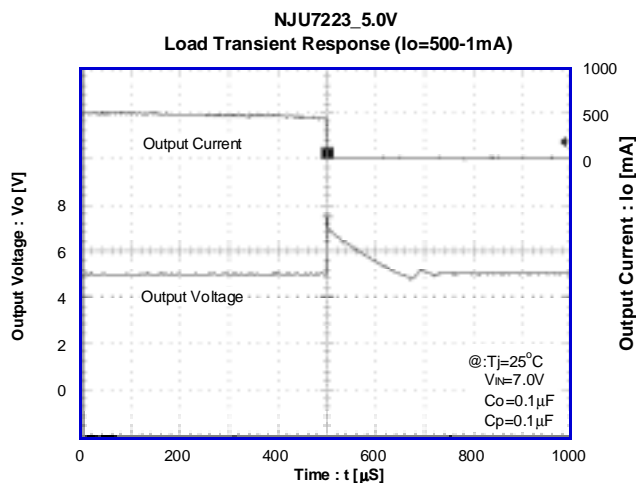
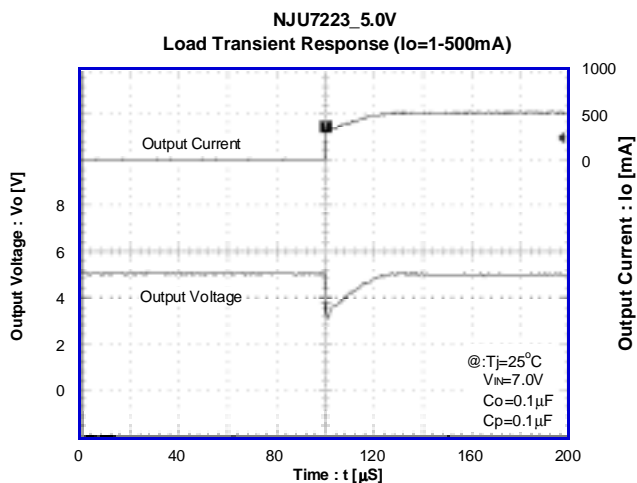
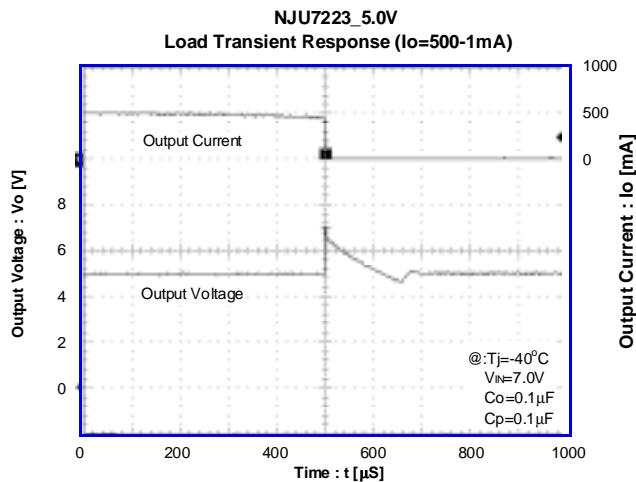
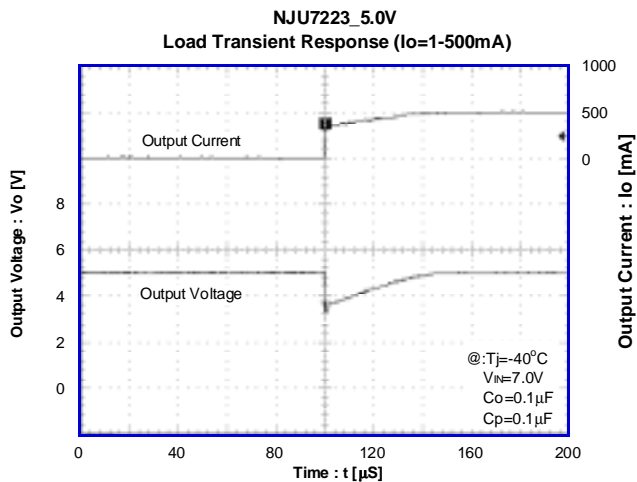

[CAUTION]
The specifications on this databook are only given for information, without any guarantee as regards either mistakes or omissions. The application circuits in this databook are described only to show representative usages of the product and not intended for the guarantee or permission of any right including the industrial rights.